

G3VM-□BR□/□ER□

MOS FET继电器 DIP6针 大容量&低导通电阻型

DIP6针封装，实现与机械式继电器相当的低导通电阻、大容量开关的MOS FET继电器

- 负载电压 20V/30V/40V/60V/100V
 - 20V产品：连续负载电流（最大）4A（8A）*
 - 30V产品：连续负载电流（最大）5A（10A）*
 - 40V产品：连续负载电流（最大）3.5A（7A）*
 - 60V产品：连续负载电流（最大）4A（8A）*
 - 100V产品：连续负载电流（最大）3.5A（7A）*
- * C连接时的值为（ ）中的值。

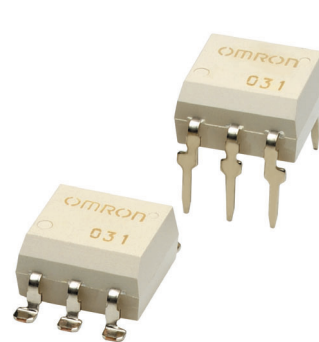

※标记内容与实际商品有所不同。



符合RoHS

■用途示例

- 通信设备
- 安全设备
- 各种电源
- 各种计量仪器
- 工业设备

■形状

（单位：mm，平均值）

DIP6针

印刷基板用端子

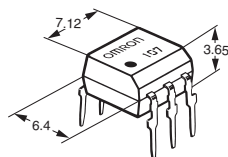

表面安装端子

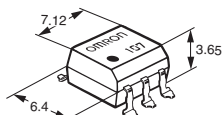

※标记内容与实际商品有所不同。

■型号标准

G3VM-□□□□□

① ② ③ ④ ⑤

- ① 负载电压
2：20V
3：30V
4：40V
6：60V
10：100V
- ② 接点结构
1：1a（SPST-NO）
- ③ 形状
B：DIP6针 印刷基板用端子
E：DIP6针 表面安装端子
- ④ 附加功能
R：低导通电阻型
- ⑤ 其他
规格重复时，为注册顺序添加连续编号。

■种类

形状	接点结构	负载电压 (最大)*	连续负载电流 (最大)*		包装状态/杆状		包装状态/带状			
			A、B连接	C连接	型号		最小包装 单位(个)	型号	最小包装 单位(个)	
DIP6	1a	20V	4A	8A	印刷基板用端子	表面安装端子	50	G3VM-21ER(TR)	1,500	
		30V	5A	10A	G3VM-21BR	G3VM-21ER		G3VM-31ER(TR05)	500	
		40V	3.5A	7A	G3VM-31BR	G3VM-31ER		G3VM-41ER(TR)	1,500	
		60V	2.5A	—	G3VM-41BR	G3VM-41ER		G3VM-61ER(TR)		
			3A	6A	G3VM-61BR	G3VM-61ER		G3VM-61ER1(TR)		
			4A	8A	G3VM-61BR1	G3VM-61ER1		G3VM-61ER2(TR05)	500	
		100V	2A	4A	G3VM-61BR2	G3VM-61ER2		G3VM-101ER(TR)	1,500	
			3.5A	7A	G3VM-101BR	G3VM-101ER		G3VM-101ER1(TR05)	500	
						G3VM-101BR1		G3VM-101ER1		

* 连续负载电流（最大）、负载电压（最大）：表示峰值AC、DC。

注1. 带状包装（表面安装端子型）无标准在库机种。

注2. 请购带状包装（表面安装端子型）时，请在型号末位加上(TR)。

G3VM-□BR□/□ER□

■ 绝对最大额定值 (Ta=25°C)

项目		符号	G3VM-21BR G3VM-21ER	G3VM-31BR G3VM-31ER	G3VM-41BR G3VM-41ER	G3VM-61BR G3VM-61ER	G3VM-61BR1 G3VM-61ER1	G3VM-61BR2 G3VM-61ER2	G3VM-101BR G3VM-101ER	G3VM-101BR1 G3VM-101ER1	单位	条件	
输入侧	LED正向电流	I _F	30								mA		
	重复峰值LED正向电流	I _{FP}	1								A	100μs脉冲、100pps	
	直流正向电流降低比率	ΔI _F /°C	-0.3								mA/°C	Ta ≥ 25°C	
	LED反向电压	V _R	5	6	5		6	5	6	V			
粘合部位温度		T _J	125								°C		
负载电压 (峰值AC/DC)		V _{OFF}	20	30	40	60		100		V			
输出侧	连续负载电流	A连接	I _O	4	5	3.5	2.5	3	4	2	3.5	A	A连接: 峰值AC/DC B、C连接: DC
		B连接		8	10	7	—	6	8	4	7		
		C连接											
	导通电流降低比率	A连接	ΔI _O /°C	-40	-50	-35	-22	-30	-40	-20	-35	mA/°C	Ta ≥ 25°C
		B连接		-80	-100	-70	—	-60	-80	-40	-70		
C连接													
脉冲导通电流		I _{OP}	12	15	10.5	7.5	9	12	6	10.5	A	t=100ms、Duty=1/10	
粘合部位温度		T _J	125								°C		
输入输出间耐电压 (注1)		V _{I-O}	2,500								V _{rms}	AC持续1分钟	
使用环境温度		T _a	-40~+85	-40~+110	-40~+85	-20~+85	-40~+85	-40~+110	-40~+85	-40~+110	°C	无结冰、无结露	
保存温度		T _{stg}	-55~+125			-40~+125		-55~+125			°C		
焊接温度条件		—	260								°C	10s	

(注1): 测量输入输出间的耐电压时, 分别对LED针脚、受光侧针脚统一地施加电压。

连接示例

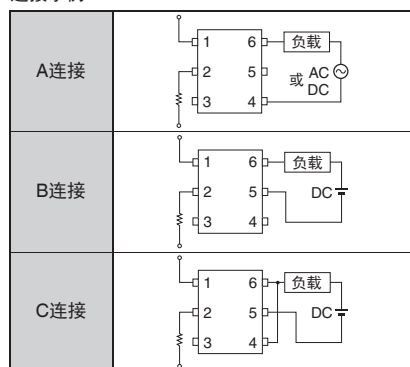

注: G3VM-61BR/ER仅A连接。

■ 电气性能 (Ta=25°C)

项目		符号	G3VM-21BR G3VM-21ER	G3VM-31BR G3VM-31ER	G3VM-41BR G3VM-41ER	G3VM-61BR G3VM-61ER	G3VM-61BR1 G3VM-61ER1	G3VM-61BR2 G3VM-61ER2	G3VM-101BR G3VM-101ER	G3VM-101BR1 G3VM-101ER1	单位	条件		
输入侧	LED正向电压	V _F	最小	1.18	1.5	1.18		1.5	1.18	1.5	V	I _F =10mA		
		标准	1.33	1.64	1.33		1.64	1.33	1.64					
		最大	1.48	1.8	1.48		1.8	1.48	1.8					
	反向电流	I _R	最大	10									μA	V _R =5V
	端子间电容	C _T	标准	70									pF	V=0、f=1MHz
输出侧	触发LED正向电流	I _{FT}	标准	0.5	0.2	0.5	1	0.5	0.3	0.5	0.2	mA	I _O =1A	
		最大	3											
	复位LED正向电流	I _{FC}	最小	0.1	0.01	0.1		0.01	0.1	0.01	0.01	mA	I _{OFF} =10μA	
		标准	20		30	65	40	35	100	50				
		最大	50	40	60	100	70	60	200	80				
最大输出 导通电阻	A连接	RON	标准	10		15	—	20	18	50	24	mΩ	G3VM-21BR/21ER/41BR/41ER/61BR1/61ER1/101BR/101ER: I _F =5mA, I _O =2A G3VM-61BR/61ER: I _F =10mA, I _O =10mA, I _O =2A G3VM-31BR/31ER/61BR2/61ER2/101BR1/101ER1: I _F =5mA, I _O =3A, t<1s	
		标准	10		15	—	20	18	50	24				
		标准	5		8	—	10	9	25	12				
开路时漏电流	I _{LEAK}	标准	—	0.01	—	0.001	—	0.01	—	0.01	μA	V _{OFF} =负载电压额定值		
		最大	1		0.01	1								
端子间电容	C _{OFF}	标准	1000	1100	1000	400	1000	640	1000	450	pF	V=0、f=1MHz		
输入输出间电容	C _{I-O}	标准	0.8									pF	f=1MHz、V _S =0V	
输出输入间电容绝缘 电阻	R _{I-O}	最小	1000									MΩ	V _{I-O} =500VDC、R _{oH} ≤60%	
		标准	10 ⁸											
动作时间	t _{ON}	标准	2.5	0.8	2	1.5	2	1.2	2	0.8	ms	I _F =5mA、R _L =200Ω、 V _{DD} =20V *		
		最大	5		3	5								
复位时间	t _{OFF}	标准	0.1		0.2	0.1								
		最大	1	0.5	1	0.6	1	0.5	1	0.5				

* 动作、复位时间

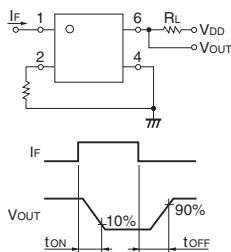

■ 推荐动作条件

为以高可靠性使用，相对于最大额定值和电气性能，以考虑降额为你推荐动作条件的指标。

各项目为独立条件，非同时满足多条件。

项目	符号	G3VM-21BR G3VM-21ER	G3VM-31BR G3VM-31ER	G3VM-41BR G3VM-41ER	G3VM-61BR G3VM-61ER	G3VM-61BR1 G3VM-61ER1	G3VM-61BR2 G3VM-61ER2	G3VM-101BR G3VM-101ER	G3VM-101BR1 G3VM-101ER1	单位	
负载电压 (峰值AC/DC)	V _{DD}	最大	16	24	32	48		80		V	
动作LED正向电流	I _F	最小	5			10	5			mA	
		标准	10			—	10				
		最大	25			20	25				
连续负载电流 (峰值AC/DC)	I _O	最大	4	5	3.5	2.5	3	4	2	3.5	A
动作温度	T _a	最小	-20	-40	-20		-40		-20	-40	°C
		最大	65	85	65	60	65	85	65	85	

■ 绝缘结构尺寸

项目	最小	单位
沿面距离	7.0	mm
空间距离	7.0	
绝缘体厚度	0.4	

■ 参考数据

● LED正向电流—环境温度

G3VM-21BR/21ER/41BR/41ER/
61BR1/61ER1/101BR/101ER

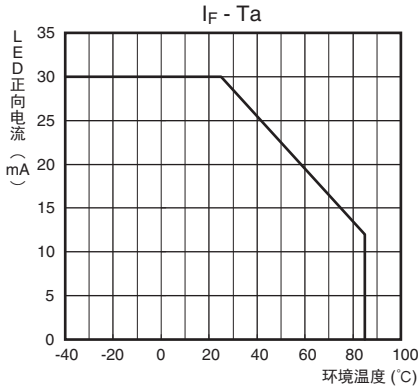

G3VM-61BR/61ER

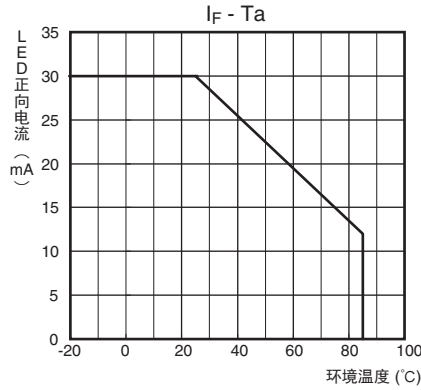

G3VM-31BR/ER,-61BR2/ER2,
-101BR1/ER1

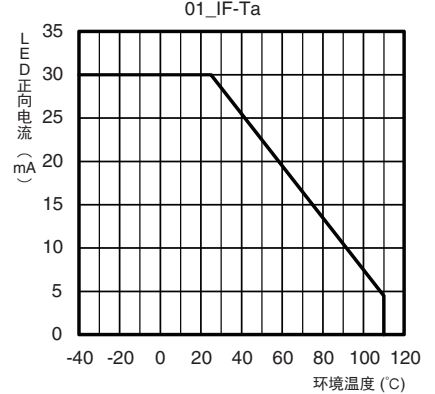

● LED正向电流—LED正向电压

G3VM-21BR/21ER/41BR/41ER/61BR/
61ER/61BR1/61ER1/101BR/101ER

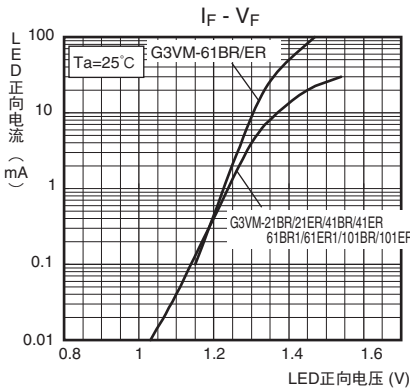

G3VM-31BR/ER,-61BR2/ER2,
-101BR1/ER1

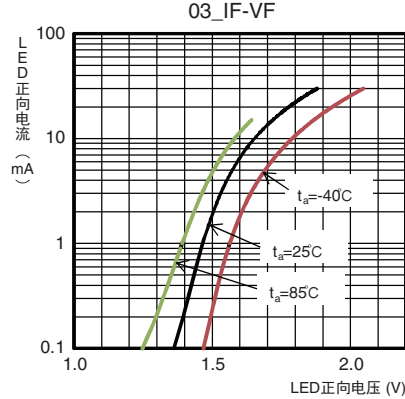

● 连续负载电流—环境温度

G3VM-21BR/21ER/41BR/41ER

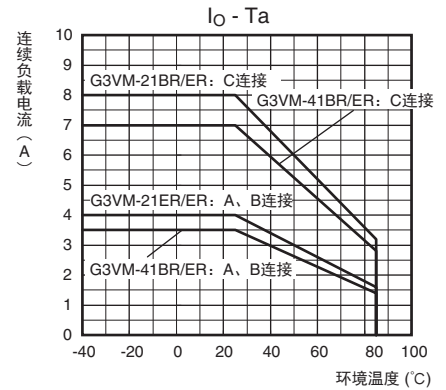

G3VM-61BR1/61ER1/101BR/101ER

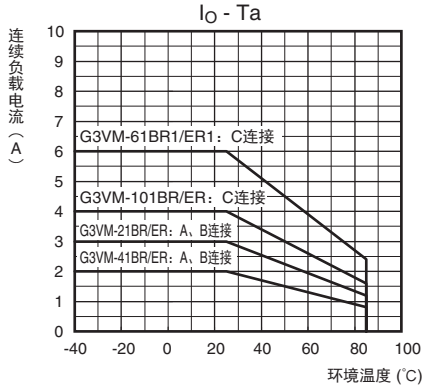

G3VM-61BR/61ER

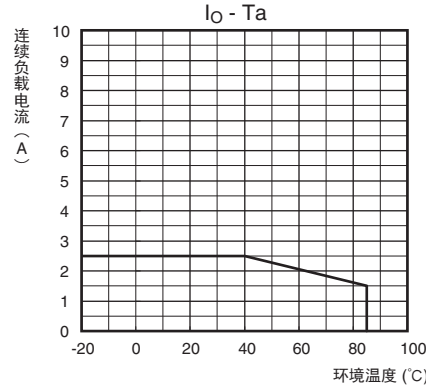

G3VM-31BR/ER,-61BR2/ER2,-101BR1/ER1

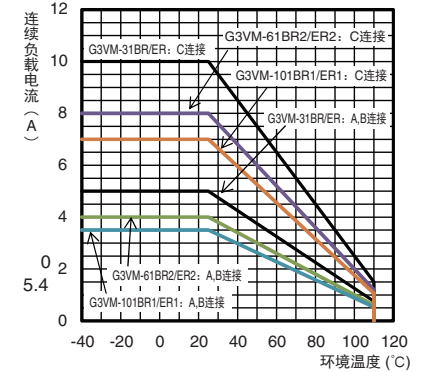

● 连续负载电流—MOS FET导通电压

G3VM-21BR/21ER/41BR/41ER/61BR/
61ER/61BR1/61ER1/101BR/101ER

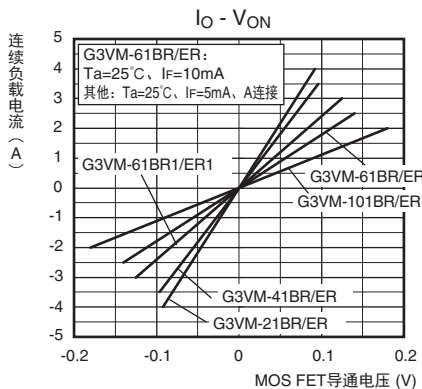

G3VM-31BR/31ER/61BR2/61ER2/
101BR1/101ER1

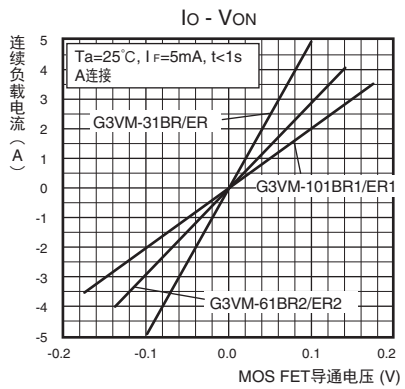

● 输出导通电阻—环境温度

G3VM-21BR/21ER/41BR/41ER/61BR/
61ER/61BR1/61ER1/101BR/101ER

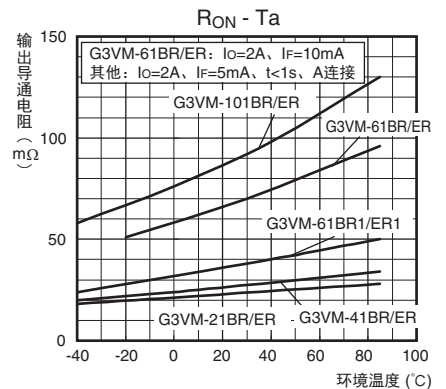

参考数据

G3VM-31BR/31ER/61BR2/61ER2/
101BR1/101ER1
05_ Ron-Ta

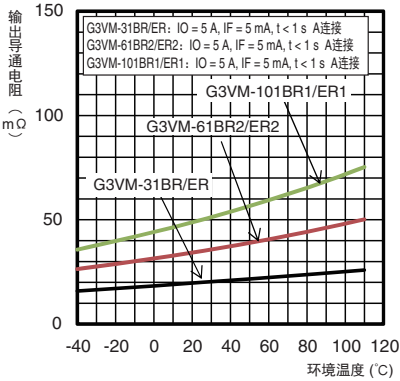

● 触发LED正向电流—环境温度
G3VM-21BR/21ER/41BR/41ER/61BR/
61ER/61BR1/61ER1/101BR/101ER

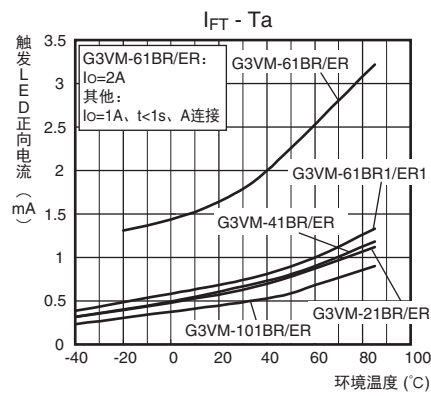

G3VM-31BR/31ER/61BR2/61ER2/
101BR1/101ER1
06_I FT-Ta

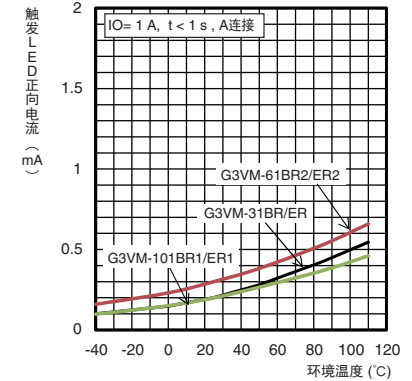

● 动作、复位时间—LED正向电流
G3VM-21BR/21ER/41BR/41ER

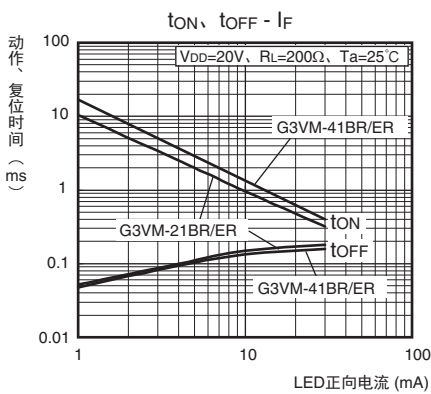

G3VM-61BR/61ER/61BR1/61ER1/101BR/101ER

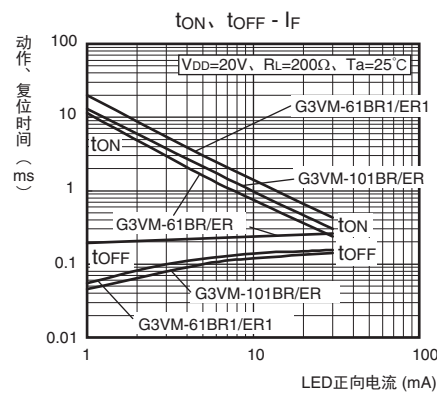

G3VM-31BR/31ER/61BR2/61ER2/101BR1/101ER1

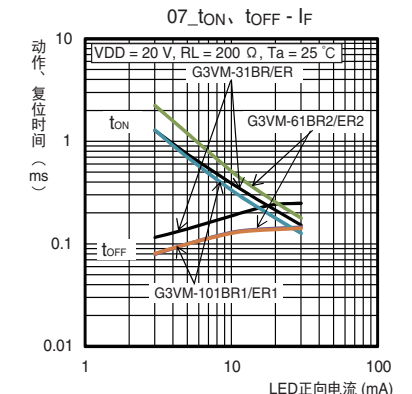

● 动作、复位时间—环境温度
G3VM-21BR/21ER/41BR/41ER

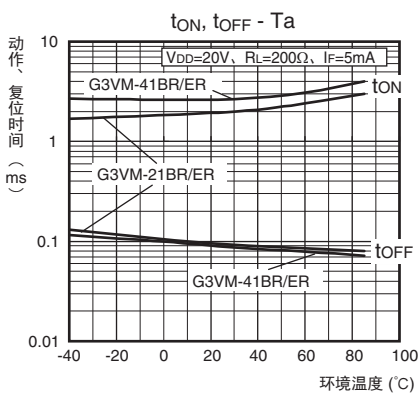

G3VM-61BR/61ER/61BR1/61ER1/101BR/101ER

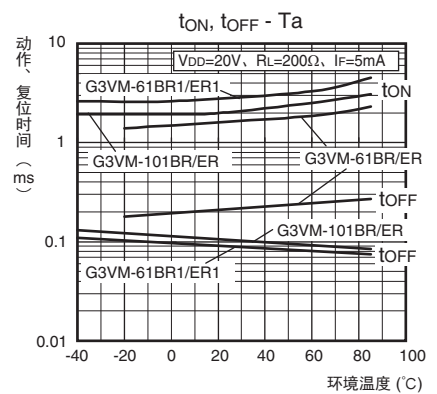

G3VM-31BR/31ER/61BR2/61ER2/101BR1/101ER1

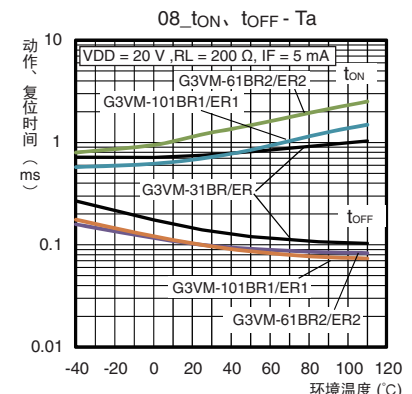

● 开路时漏电流—环境温度
G3VM-21BR/21ER/41BR/41ER/61BR/
61ER/61BR1/61ER1/101BR/101ER

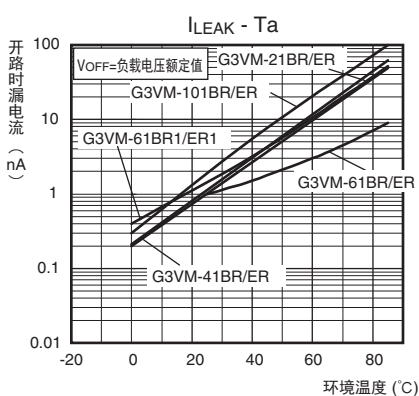

G3VM-31BR/31ER/61BR2/61ER2/
101BR1/101ER1

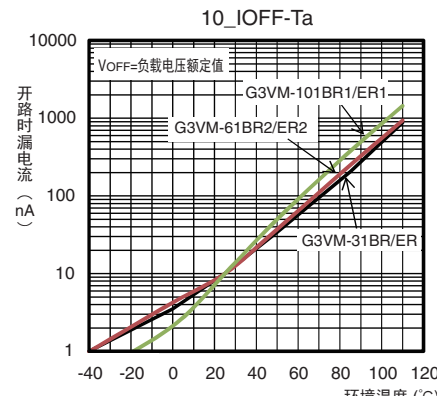

G3VM-□BR□/□ER□

■外观/端子配置/内部接线图

●外观

DIP (Dual Inline Package)

DIP6针

G3VM-21BR/ER、-31BR/ER、-41BR/ER、-61BR1/ER1、
-61BR2/ER2、-101BR/ER、-101BR1/ER1

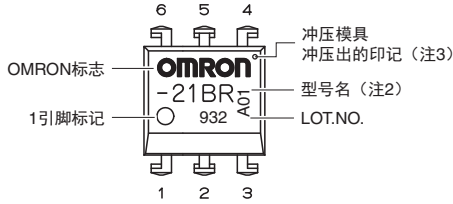

●端子配置/内部接线图 (TOP VIEW)

G3VM-21BR/ER、-31BR/ER、-41BR/ER、-61BR1/ER1、
-61BR2/ER2、-101BR/ER、-101BR1/ER1

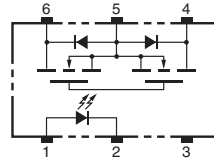

DIP6针 (特殊) *
G3VM-61BR/ER

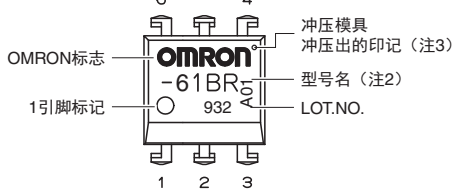

G3VM-61BR/ER

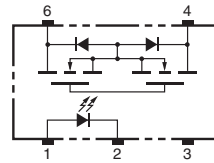

注1: 标记内容与实际商品有所不同。注2: 产品的型号中没有标明“G3VM”。注3: 1引脚标记的对角侧留有冲压模具冲压出的印记。
*与DIP6的外形尺寸一致, 端子数不同。

■外形尺寸

(单位: mm)

G3VM-21BR/31BR/41BR/61BR1/61BR2/101BR/101BR1 G3VM-21ER/31ER/41ER/61ER1/61ER2/101ER/101ER1



印刷基板用端子

质量: 0.4g

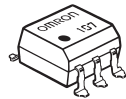

表面安装端子

质量: 0.4g

印刷基板加工尺寸 (BOTTOM VIEW)

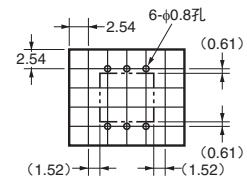

实际焊盘尺寸 (推荐值) (TOP VIEW)

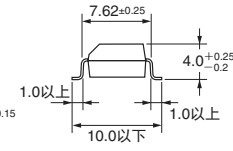
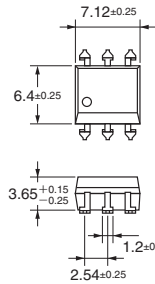
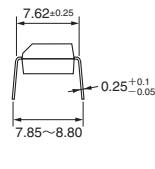
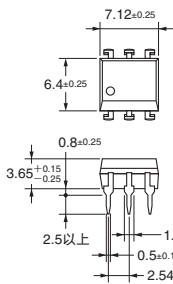
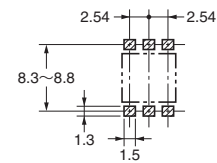

※标记内容与实际商品有所不同。

G3VM-61BR

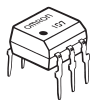

印刷基板用端子

质量: 0.4g

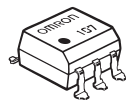

表面安装端子

质量: 0.4g

印刷基板加工尺寸 (BOTTOM VIEW)

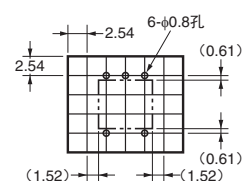

实际焊盘尺寸 (推荐值) (TOP VIEW)

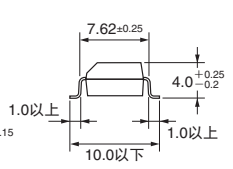
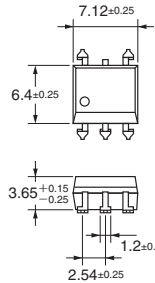
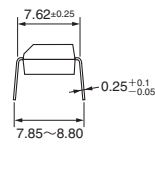
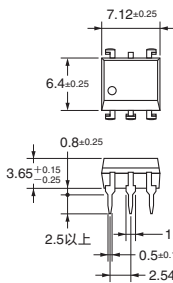
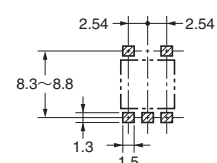

※标记内容与实际商品有所不同。

■ 国际标准认证额定值

UL标准认证型号 

标准	极数或接点结构	文件No.
UL认证品 (Recognized)	1a (SPST-NO)	E80555

■ 请正确使用

- 共通注意事项，请参见「MOS FET继电器 共通注意事项」。

订购前请务必阅读我司网站上的“注意事项”。

欧姆龙电子部品 (中国) 统辖集团

网站

欧姆龙电子部品贸易 (上海) 有限公司

<https://www.ecb.omron.com.cn>Cat. No. **K303-CN-02**

2021年1月